



Power Management System



Power Management System

Features

The Mega-Guard Power Management System (PMS) is an advanced system for full automation of power plant, including power management, diesel engine control, generator control, synchronizing, generator protection and optional diesel engine safety system. Each generator set is equipped with its own independent and autonomous PMS system. This ensures the highest degree of reliability and availability. The Mega-Guard PMS is supplied as a complete product and no additional components are needed for automation of a low voltage switchboard up to 690VAC.

The Mega-Guard PMS is operated through a user friendly touchscreen (5,7" or 8") for intuitive operation and monitoring of power plant.



PMS Operator Panel

Mega-Guard PMS general specification	
Maximum number of PMS	16
Diesel generator function	✓
Shaft generator function	✓
Auto bus-tie breaker function	✓
Emergency generator function	✓
Shore connection function	✓
Auto start and synchronize	✓
Manual start and synchronize	✓
Load sharing	✓
Consumer block enable	✓
Preference tripping	✓
Blackout handling	✓
1st and 2nd standby selection	✓
Running hours	✓
Meter (kW, Hz, V, A, pf, kVAr)	✓
Protection functions (see ANSI table)	✓
Communication Modbus RS485	✓
Communication Modbus TCP-IP	✓
Communication J1939, CAN bus	optional
Differential tripping	optional
Diesel engine safety system	optional

Reliable operation is guaranteed by 6 operator pushbuttons for essential functions. All essential power plant parameters are displayed on the touchscreen. The touchscreen supports swiping in between pages and activating sub menus with the touch of a finger.

Mega-Guard PMS is built-up with the following three items for each generator:

- ▶ **PMS Operator Panel** for flush panel mounting in switchboard
- ▶ **PMS Controller** for DIN rail mounting inside switchboard
- ▶ **I/O Cable** interconnecting the PMS Operator Panel and the PMS Controller

Both the PMS Operator Panel and the PMS Controller are equipped with a powerful ARM microprocessor for independent function execution.

Application

Mega-Guard PMS can be configured for a mixture of the following applications:

- ▶ diesel generator
- ▶ shaft generator
- ▶ automatic bus tie breaker
- ▶ emergency generator
- ▶ shore connection

Mega-Guard PMS provides for auto starting, synchronisation and load sharing functions. Metering functions include 3 phase voltage, current, frequency and power measurement, calculation of power factor and running hours. Diesel engine, generator and circuit breaker are controlled and monitored by Mega-Guard PMS. Safety functions are executed in accordance with the applicable ANSI standard (see PMS protection function table).

Other functions include black-out start, consumer enable when enough power and preferent tripping in case not enough power available.

Mega-Guard PMS includes a PLC programming option and graphic editor which is not needed for most switchboard applications. Special applications can be programmed with the built-in and optional PLC logic. The PLC logic is in accordance with the IEC61131 standard.

Mega-Guard PMS can be extended with additional modules to realize following functions:

- ▶ Safety system for diesel engine
- ▶ Differential tripping
- ▶ Check synchronizer with back-up measurement of kW, V, A, Hz and Cos ϕ
- ▶ Analog control for frequency and voltage
- ▶ Additional Controllers for user functionality (requires PLC programming option)

Installation and commissioning of Mega-Guard PMS can be executed by switchboard builder and does not require special skills. The technician can easily set switchboard and power plant parameters in the Mega-Guard PMS with the user friendly PMS Operator Panel with touchscreen. Parameters such as generator power, number of generators, bus tie breaker, busbar nominal voltage, alarm limits, type of generator etc. can easily be entered in the menu driven operator interface.

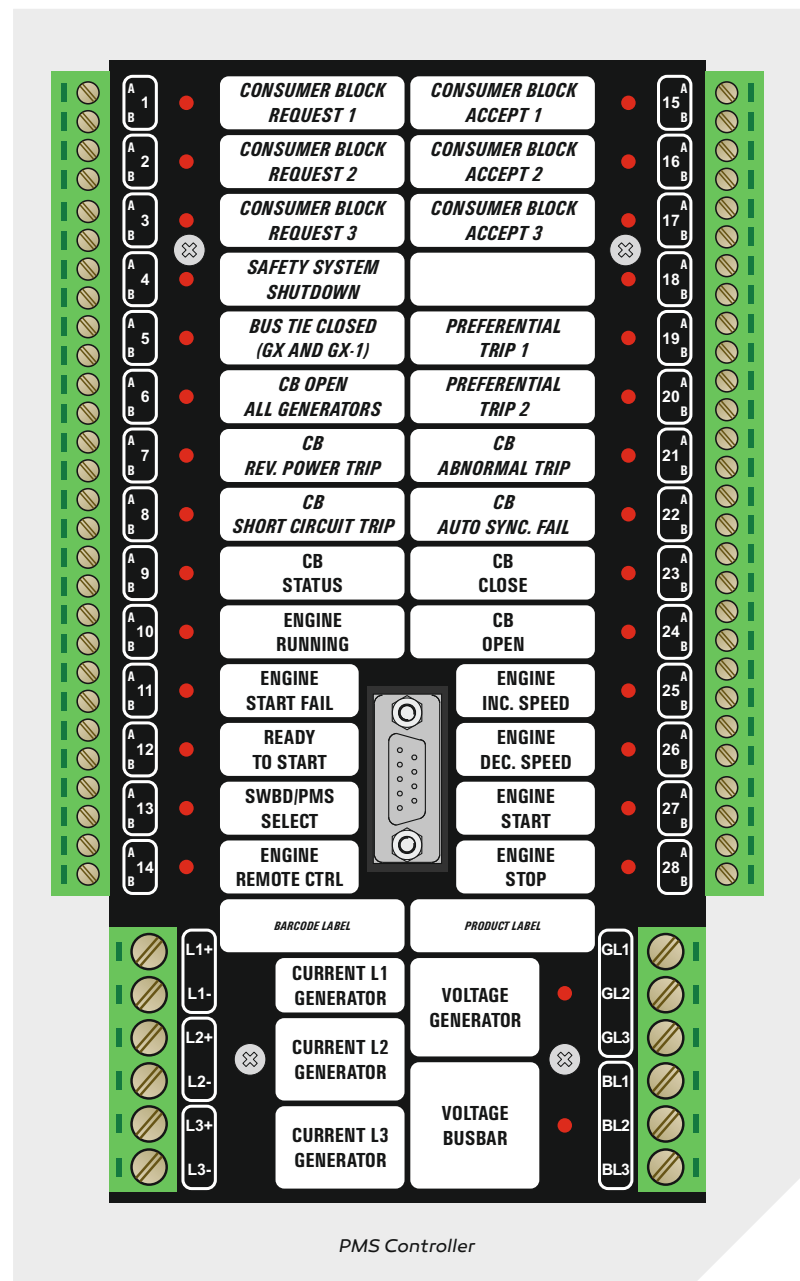

PMS system lay-out

PMS Operator Panel

The PMS Operator Panel is supplied in a compact DIN compatible housing for flush panel mounting in switchboard. The PMS Operator Panel is equipped with a user friendly touchscreen and a powerful ARM microprocessor which executes the power management functions and optional PLC logic.

The PMS Operator Panel is available in three versions for the following market segments:

- ▶ **Commercial ships** : 5.7" touchscreen and metal front with 6 pushbuttons
- ▶ **Mega yachts** : 5.7" touchscreen with full glass front
- ▶ **Navy ships** : 8" touchscreen and metal front with 6 pushbuttons

PMS Controller

The PMS Controller is installed on a TS35 DIN rail inside main switchboard at each generator section. I/O signals from generator, busbar, circuit breaker and engine are directly connected to this Controller. The PMS Controller is equipped with a powerful ARM microprocessor executing metering, safety and generator control functions. The PMS Controller can also be delivered as an independent check synchronizer.

The PMS Controller has the following inputs and outputs:

- ▶ 3 phase busbar voltage (0-690VAC)
- ▶ 3 phase generator current (0-5A)
- ▶ 14 digital inputs
- ▶ 3 phase generator voltage (0-690VAC)
- ▶ 14 relay outputs

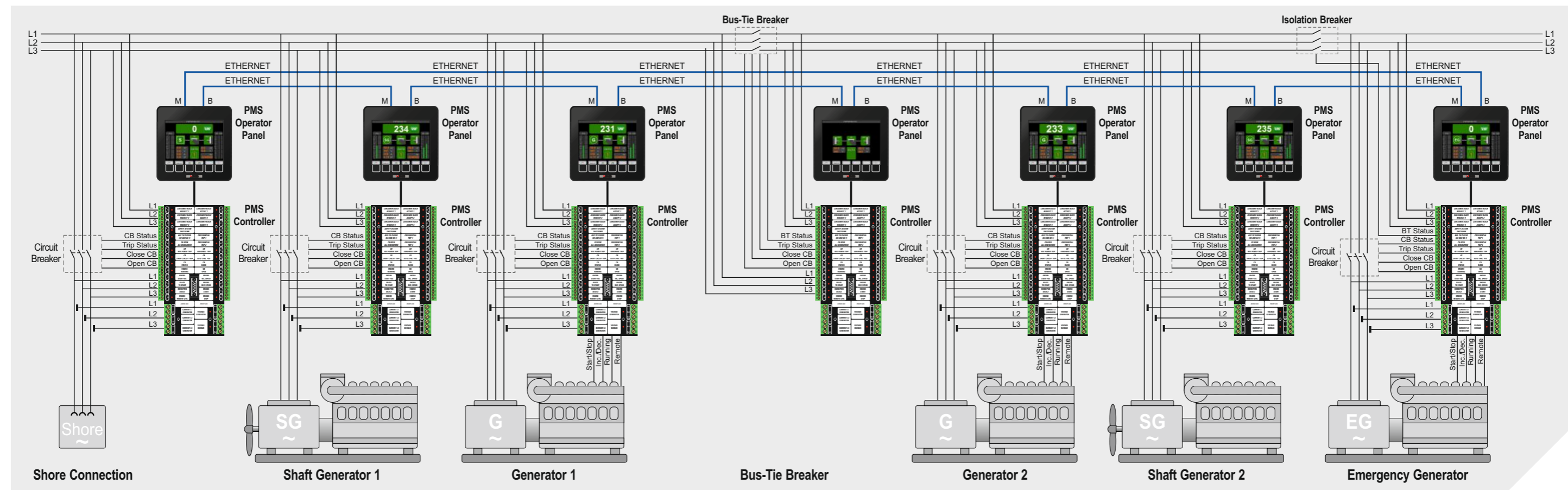

The colour touch screen continuously displays metering values (kW, Hz, V, A, pf, kVAr), circuit breaker status, standby generator number and alarms. Operator mode selection can be executed with pushbuttons or the touchscreen. The rear side of the PMS Operator Panel is equipped with detachable terminal strips, four Ethernet ports and a USB port. Communication between Mega-Guard PMS systems takes place via Ethernet wired in a loop and occupies two Ethernet ports on each PMS Operator Panel. The two remaining Ethernet ports can be used for connection to e.g. an external monitoring system and/or to the diesel engine. RS485 and CAN bus communication are supported as well. The USB port is used for a memory stick to upload or download an application program. Terminal strips are available to connect the 24VDC power supply and a number of inputs and outputs. The switchboard can be configured in such a way that installation of separate gauges is not required with Mega-Guard PMS.

PMS Controller typical functions relay outputs	
CB close / open	CB auto sync fail
Engine start / stop	AVR increase voltage
Engine increase / decrease speed	AVR decrease voltage
Consumer block accept	Frequency alarm high / low
Preferential trip	Voltage alarm high / low
Shutdown	Reverse power trip alarm
CB abnormal trip	Blackout

PMS Controller typical functions digital inputs	
CB status	Safety system shutdown
Engine running	Bus tie closed
Engine start fail	CB open all generators
Ready to start	CB reverse power trip
SWBD / PMS select	CB short circuit trip
Engine remote control	Blackout detected
Consumer block request	Harbour mode

The PMS Controller is connected to the PMS Operator Panel via an I/O Cable. The I/O Cable is standard available in two lengths: 3m and 5m.

PMS configuration

PMS configuration



PMS Operator Panel with glass front

The PMS can be configured for the particular application via the touch screen or through an external PC connected with Ethernet communication link. All power plant functions, parameters, inputs and outputs can be configured with a menu driven and user friendly operator interface. This can easily be executed by switchboard builder as no specific programming knowledge is required. Unauthorized access is prohibited by password protection. The following configuration pages are available:

- ▶ main settings
- ▶ alarm limits
- ▶ I/O
- ▶ start/stop
- ▶ CB open/close
- ▶ load sharing
- ▶ auto start/stop
- ▶ consumer
- ▶ preferential group

A back-up of the configuration can be made on an external PC or on a USB stick connected to the USB port.

PMS specification and protection

PMS Operator Panel	
5,7" Touchscreen with 6 pushbuttons metal front	size 144x144x50mm
5,7" Touchscreen with glass front	size 144x144x50mm
8" Touchscreen with 6 pushbuttons metal font	size 144x216x50mm
I/O Bus connector	✓
Ethernet ports	4
RS485 ports	2
USB maintenance port	1
PWM output	1
Relay output	2
Analog input	2
Digital input	2
Micro processor	ARM
PLC programming with graphic editor	option
Power supply	24Vdc (-25% ~ +30%)
Mounting	flush panel
Mounting bracket	2

PMS Controller and IO Cable	
3 phase voltage input up to 690VAC	2
3 phase current input up to 5A	1
Relay output (configurable)	14
Digital input (configurable)	14
I/O Board connector	2
Micro processor	ARM
Text window for each I/O point	✓
DIN rail mounting with clips	TS35 rail
Dimensions	200x127x34
Power supply via I/O Cable	24VDC
I/O Cable with 2x 9 pole connector	3m or 5m length

PMS protections with ANSI number	
Engine over-speed	12*
Engine under-speed	14*
Matching device	15
Overexcitation	24
Automatic synchronizing	25
Generator undervoltage	27
Busbar undervoltage	27B
Generator overload /rev. power	32
Generator reverse current	37
Generator loss of excitation	40
Current unbalance	46
Phase sequence voltage	47
Thermal overload protection	49*
Generator overcurrent	50
Fast overcurrent	51
Voltage dependent overcurrent	51V*
Power factor	55
Generator overvoltage	59
Busbar overvoltage	59B
Voltage unbalance	60
Ground overvoltage	64*
Start inhibit	66
Auto reclosing	79
Generator under-frequency	81
Generator over-frequency	81
Busbar under-frequency	81B
Busbar over-frequency	81B
Non preferential tripping	86
Differential protection	87*
Trip circuit supervision	94
Inrush blocking	95

* = optional

Mounting & dimensions



PMS Operator Panel
5,7" touchscreen with metal front



PMS Operator Panel
5,7" touchscreen with glass front



PMS Operator Panel
8" touchscreen with metal front

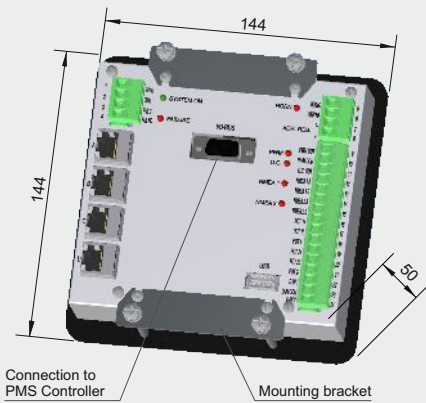

PMS Operator Panel
Rear view 5,7"

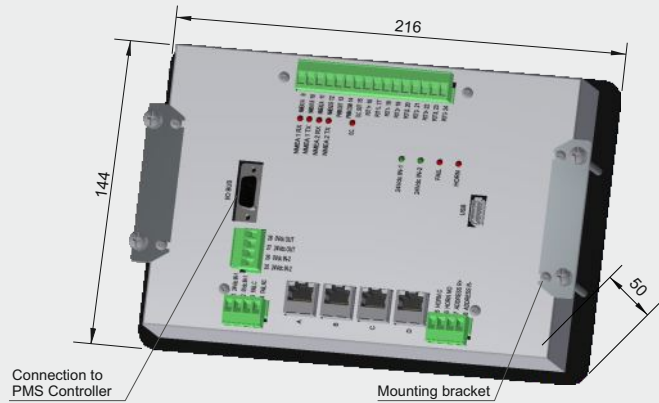

PMS Operator Panel
Rear view 8"

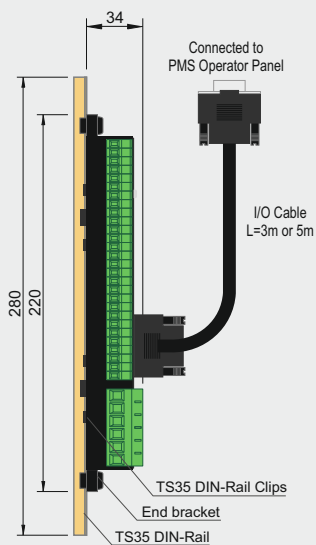

Side view

PMS Controller

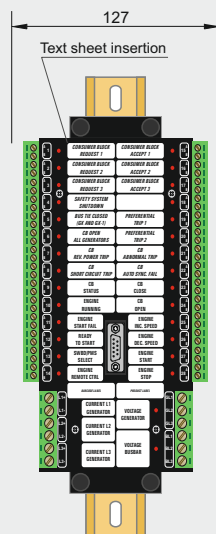

Front view

PMS environmental and approvals

Environmental conditions	IEC60945
Safety	IEC60255
Accuracy	Class 1.0
Ambient temperature	-25 ~ 70°C
Class approval	LRS, DNV-GL, ABS RINA, BV, RMRS, CCS, NKK, PRS, KR Incl. DP1, DP2, DP3
Measuring voltage	0 - 690VAC +/-20%
Measuring current	0 - 5A nominal
Measuring current max	up to 200%
Digital inputs	potential free contacts
Digital inputs N.O. or N.C.	jumper selectable
Relay outputs	potential free outputs
Relay outputs N.O. or N.C.	jumper selectable 32VDC-2A 250VAC-0,5A
Galvanic isolation AC side	2500VAC, 50Hz, 1 min
Galvanic isolation I/O side	550VAC, 50Hz, 1 min

Vessel Management System



Power Management System



Fire Alarm System



CCTV Video Distribution



Ship Performance Monitor



Fleet Management System



Integrated Navigation System

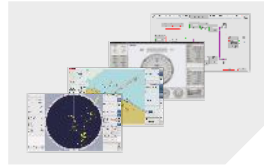

Heading Control System



Propulsion Control System



Dynamic Positioning System



BNWAS Watch Alarm System



Navigation Light Control



Wiper Control System



Energy Management System



Electric Propulsion Motor



Electric Steerable POD



High Power Inverter



DC bus Generator



Electric Energy Storage



Electric Fin Stabilizer

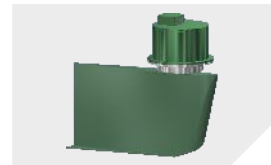

*Ship automation,
navigation and
electric propulsion*